

ADJ1005 Smart Skimmer with Extended Travel and 5500ES Programmable Controller 16 Skimmers Operations Manual

Caution:

**Read rules for safe operation and instructions
carefully.**

© Copyright 1997 REV 07/2010

XITECH

Instruments, Inc.

06 Camino De Los Desmontes, Placitas, New Mexico 87043

Phone: 505-867-0008 Fax: 505-867-0212

Web site: www.xitechinc.com

E-mail: xitechinc@xitechinc.com

3 YEAR WARRANTY

This product is warranted to the original purchaser to be free from defective materials and workmanship. Under this warranty the product will be repaired or replaced at our option, without charge for parts or labor.

This warranty does not apply to the skimmer hydrophobic filter, air logic valve or diaphragm.

The period of this warranty covers 3 years on parts and labor from date of original purchase.

This warranty entitles the original purchaser to have the warranted parts and labor rendered at no cost for the period of the warranty described above when the instrument is carried or shipped, pre-paid, to our factory, together with proof of purchase.

RULES FOR SAFE OPERATION

- 1. Please review carefully and abide by the maximum limits placed on each type of equipment.**
- 2. Please follow standard electrical practices and safety precautions when installing AC power to our products.**

Product Recovery System Installation

The system (Figure 1) relates to floating hydrocarbon recovery in wells four inches in diameter and larger. This system includes: an intrinsically safe ADJ1005 pneumatic Smart Skimmer, with an adjustable float (Figure 2), which removes only the product to a sheen down to 200 feet deep; and a programmable Controller Model 5500ES which operates up to 16 skimmers intermittently, records run time, and has a high level tank shutoff assembly.

STEP 1. Mount programmable Controller Model 5500ES (Figure 3) in a vertical position near the air source, power source, and holding tank, if possible. **CAUTION:** The Model 5500ES is NOT intrinsically safe. If this controller must operate in a CLASS I area, use the XITECH Model 2550ES CLASS I Controller instead. Air supply needs to be free of WATER and OIL to have minimum maintenance.

STEP 2. Install holding tank shutoff assembly into holding tank (a 2” standard pipe inlet will be required in the holding tank). The level of product in the holding tank can be set by raising or lowering the liquid level sensor attached to the rod. Wire the sensor cable into the controller (Figure 3). **NOTE:** If additional signal cable is needed to position the holding tank assembly further away from the controller, use 18 gauge 2-conductor wire.

STEP 3. Attach power line from the AC Line to the controller (Figure 3). Turn on the controller power switch. If the red “Product Tank Full” light stays on, you have a problem with tank shutoff wiring. Turn off the power switch and re-check the tank shutoff wiring. If the light continues to stay on, call the factory.

STEP 4. Install 1/2” OD air supply tubing from the main air source to the INLET of the Controller. Do NOT apply air pressure YET.

ADJ1005 Smart Skimmer and 5500ES Controller with Tank Shutoff

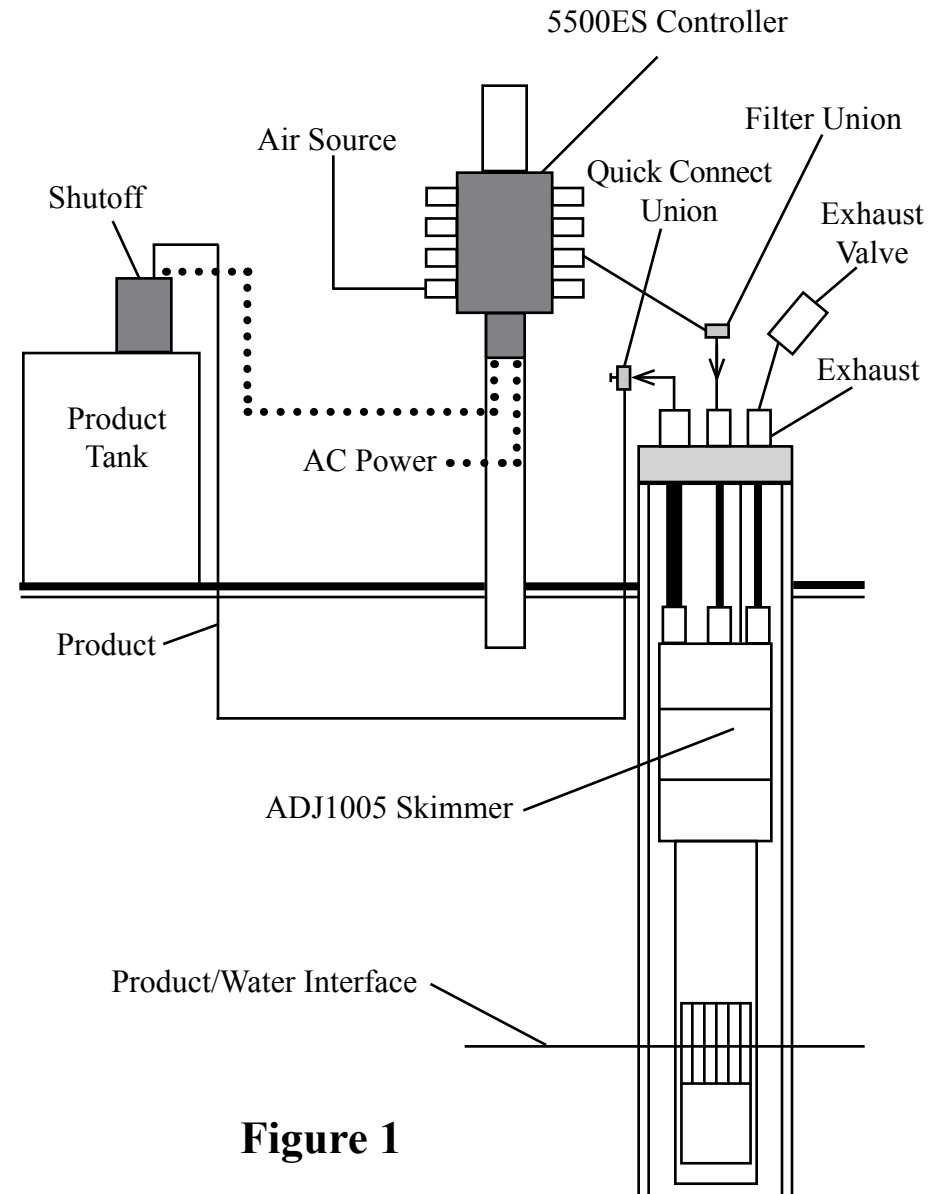

Figure 1

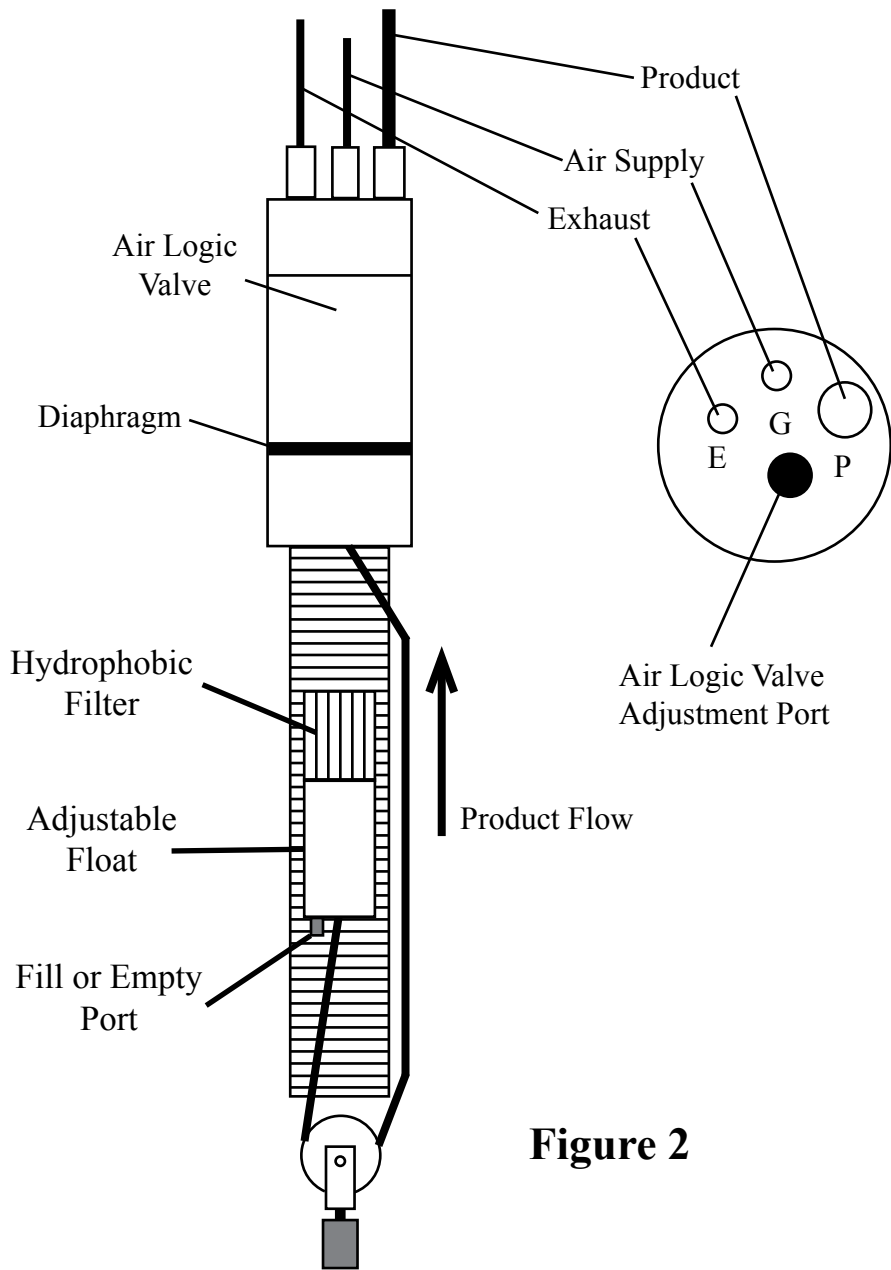

Figure 2

STEP 5. Install horizontal air supply lines to each well. Use 3/8" OD tubing for horizontal runs. **CAUTION:** Please keep dirt from getting into these lines! Attach a filter union onto the end of this line at the well vault.

STEP 6. Install horizontal product return lines to each well. For INDIVIDUAL product return lines use 1/2" OD tubing for horizontal runs. For a COMMON product return line, use 3/4" OD hose for all horizontal runs. Attach a quick connect union onto the end of this line at the well vault.

STEP 7. Position the skimmer and well cap on the ground near the well. **NOTE:** If the skimmer is over 60 feet deep, use a vented design skimmer. Cut a length of 3/8" OD air supply tubing to cover the distance from the top of the well down to water/product interface, plus 5 feet. Slide enough tubing through the well cap and attach the end of the tubing to the top of the skimmer tube fitting labeled "G" (Figure 2). If the product thickness is greater than 1 foot, position the skimmer's "Black Reference Line" on skimmer well screen 1 foot below top of product. If the product thickness is less than 1 foot, position the skimmer's "Black Reference Line" on skimmer well screen at the water/product interface.

STEP 8. Cut a length of 1/2" OD product tubing same length as the air supply line. Install 1/2" OD product tubing through the well cap tube fitting labeled "P" (Figure 2). Slide enough tubing through the well cap and attach the end of the tubing to the top of the skimmer tube fitting labeled "P". **CAUTION:** Do not kink the tubing.

STEP 9. Cut another length of 3/8" OD air exhaust tubing same length as air supply line. Install 3/8" OD air exhaust tubing through the well cap tube fitting labeled "E". Slide enough tubing through the well cap and attach the end of the tubing to the top of the skimmer tube fitting labeled "E".

STEP 10. Cut a length of safety rope same length as air supply line. Attach the safety rope from inside the well cap to the top of the skimmer head. The tubing will carry the weight of the skimmer.

5500ES Controller

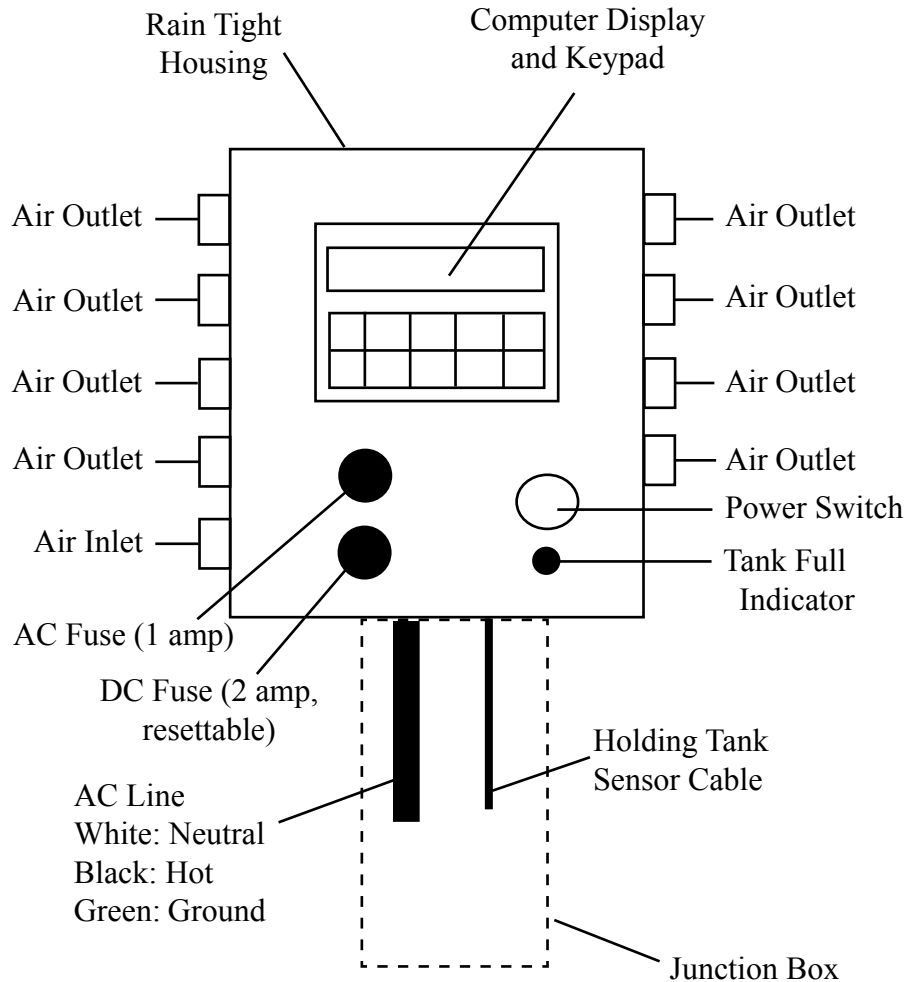

Figure 3

STEP 11. Attach the 3/8" filter union onto the 3/8" air supply line coming out of the well cap.

STEP 12. Attach the 1/2" product line coming from the well cap into the inlet of the quick connect union.

STEP 13. Attach the exhaust check valve onto the end of the 3/8" air exhaust line coming out of the well cap.

STEP 14. Set operating air supply pressure.

$$\text{AIR PRESSURE} = 35 + \frac{\text{Total Vertical Lift}}{2.85}$$

Minimum operating pressure is 35 PSI
Maximum operating pressure is 125 PSI

STEP 15. Manual operation of skimmer. Go to the Manual Control Window within the DIRECT MODE program (refer to pages 7 -12 for instructions). Turn on station #1. Observe that the skimmer is making a pumping noise. The exhaust check valve should have an intermittent pulsing sound about once every second.

STEP 16. While the skimmer is running at the desired operating air pressure above ground, confirm or adjust skimmer pulse rate. To adjust skimmer pulse rate, remove small plug at the top of the skimmer pump head and insert a small flat-head screwdriver into the air logic valve located inside the pump head. Turn clockwise to decrease pulse rate. **NOTE:** Factory sets skimmer pulse rate to 60 pulses per minute at 50 psi operating pressure. Maximum recommended pulse rate is 80 pulses per minute. Lower pulse rates will consume less air.

STEP 17. The ADJ1005 was designed with an adjustable float to compensate for the varying specific gravities of floating product. This float can be adjusted to float high or low of the water product interface. This is accomplished by adding water or removing water from the inside of the float (see page 13).

STEP 18. You are now ready to install skimmer in the well. **CAUTION:** Please remove skimmer float shipping tie wraps before placing skimmer in well.

Perform STEPS 15 & 16 for each additional skimmer.

Explanation of the 5500ES Software Windows

SET UP MODE: This is where you set the actual time and date for the computer.

DIRECT MODE: This is where you program each of the 16 outlet stations.

STATUS WINDOW: This is the first window in the Direct Mode. Here you can observe the state of each of the 16 outlet stations and the elapsed run of each outlet station. This window is also where you can reset the elapsed time of any station.

PROGRAM WINDOW #1: This is the second window in the Direct Mode. This is where you program each station's START DATE, START TIME, and DURATION or pump run time.

PROGRAM WINDOW #2: This is the third window in the Direct Mode. This is where you program each station's CYCLES per day, PERIODS or days delay between run times, and LEVEL SENSOR test mode. **CAUTION:** When the Level Sensor is OFF the 5500ES will NOT look for a High Product Tank signal.

MANUAL CONTROL WINDOW: This is the fourth window in the Direct Mode. This window is used to temporarily override any of the 16 stations present states. The "P" means that the manual control will be overridden by the program. The "M" means manual control only. OFF means that this station is not running. ON means this station will stay running until you leave this window.

Operation of the Product Recovery System

Determine how long it takes for each skimmer to remove all product from the well by using the Manual Control Mode Window. If your skimmer is less than 30 feet deep, product should show up above ground in about 2 minutes.

Observe the product being discharged by the skimmer. Be sure no water is being pumped. If water does appear, pull the skimmer out of the well and check to see if the shipping tie wraps have been removed from the skimmer well screen area. If there are no tie wraps, give Xitech a call toll free at 888-867-9483.

Record the amount of time it takes to empty the well of product. When the well is empty of product, turn off the skimmer.

If you found it took 10 minutes to pump the product off, set the "pumping time" to 5 minutes (Xitech's 1/2 Rule).

You now have to guess how many times a day to empty the well. A good guess would be once a day for slow recovering product and 3-6 times a day for fast recovering product. For ease of system observation we suggest that you run only one well at a time and that you have the nearest well run first, the next nearest well run next and so on.

PLEASE CALL XITECH FROM THE FIELD IF YOU HAVE ANY TROUBLE WITH YOUR INSTALLATION.

FINAL NOTE: Keep in mind that you are trying to empty the formation of free product over a long period of time. To do this, you must always try to keep some free product thickness in your recovery well at all time while removing free product daily.

To Set Up The Program

STEP 1. Press the “DEL” key to reset the computer. You will end up at the “SET UP MODE” window.

STEP 2. Press the MENU KEY one time to move to the “SET TIME” window.

Press the right or left arrow keys to move from field to field.

Press the up or down arrow keys to change the values.

STEP 3. Press the menu key to move to the “DATE” window.

Press the right or left arrow keys to move from field to field.

Press the up or down arrow keys to change the values.

STEP 4. Press the “DEL” key one time.

STEP 5. Press the UP arrow key one time to get to the “DIRECT MODE”.

STEP 6. Press the MENU key one time to get to the status window.

STEP 7. Clear the elapsed run times for all stations by pressing the “TIME RESET” button at every station. **VERY IMPORTANT!**

STEP 8. Press the MENU key two times to get to the 1st programming window. You should see station #, date, time, and duration in this window.

STEP 9. Enter the start date, start time, and duration (**NOTE:** If you found it took 10 minutes to pump the product off, set the “pumping time” to 5 minutes (Xitech’s 1/2 Rule)) for all stations that have a skimmer. **SUGGESTION:** Choose start times that do not overlap.

DATE: MM-DD-YY

TIME: HH:MM

DURATION: HH:MM

STEP 10. Press the MENU key one time to move to the last programming window. You should be at the “CYCLES/PERIODS” window.

STEP 11. Enter the number of times a day you want each skimmer to operate. **EXAMPLE:** If you would like the skimmer to run every eight hours, you would enter 03 Cycles (three times a day).

If you would like the skimmer to run every other day. You would move the cursor under the “C” in Cycles, press the “UP” arrow key one time, and enter 02 Periods. You must first set Cycles to 00 before changing to Periods. **NOTE:** A good guess would be once a day for slow recovering product and 3-6 times a day for fast recovering product.

NOTE: Keep in mind that you are always trying to match the recovery rate of product coming into the well from the formation. It is not good practice to operate skimmers faster than the formation recovery rate.

NOTE: The “LEVEL” should always be on if you are pumping to a holding tank.

STEP 12. Press the MENU KEY three times to get back to the “STATUS” window.

You should see the word “ACTIVE” for all stations that have a program and the word “INACTIVE” for all stations that do not have a program. If you see the word “INACTIVE” on a station that you created a program for, then you have left something out in the programming. Try again or call Xitech for assistance, toll free at 888-867-9483.

NOTE: You always want to be in the “STATUS” window when you leave the site.

Status Window Conditions:

INACTIVE Station inactive or OFF

ACTIVE Station has program but not running

RUNNING Station active, elapsed time started

HIGH TANK Stations are turned OFF

Computer Data Windows For The SET UP & DIRECT Modes

Turn on the power to the computer controller. Press the HELP KEY to read about how to operate this computer. When you have read HELP, press the MENU KEY to begin going through the different windows.

SET UP MODE:

System Time and Date

1. Mode Selection Window
CONTROL MODE
SETUP
2. Set Current Time Window
SET TIME: **HH:MM:SS**
USE 24 HOUR TIME
3. Set Current Date Window
SET DATE: **MM-DD-YY**

DIRECT MODE:

Stations Set Up, Level Sensor, and Manual Control

1. Mode Selection Window
CONTROL MODE
DIRECT
2. Station Status Window
STATION 1 INACTIVE
TOTAL TIME = **00000:00**
3. Station Set Up Window
1 START MM-DD-YY HH:MM
DURATION **HH:MM**
4. Station Cycles and Level Sensor Window
1 CYCLES 00 (00-99)
LEVEL SENSOR **ON**
5. Station Manual Control Window
1 STATION P OFF

Key Pad Descriptions

MENU: This Key changes windows.

The left & right Keys move the cursor to the next programmable field.

▲: This Key increases the value in the field the cursor is on.

▼: This Key decreases the value in the field the cursor is on.

TIME RESET: This Key will reset the elapsed run time of a station when you are in the STATUS WINDOW.

REV: This Key is to show you what software version is currently being used by your computer.

DEL: This Key will replace all programmed values with preset default values. This Key will NOT delete the elapsed run time in the STATUS WINDOW.

How To Adjust The Skimmer Float Assembly

Assembly instructions for adding water to the float body:

STEP 1: Remove skimmer assembly from skimming housing.

STEP 2: Remove screw plug at bottom of float body.

STEP 3: Empty existing water ballast first, then put in the new amount of water. Add water into open port at the bottom of float body by using Xitech's 60cc syringe.

STEP 4: Re-install screw plug into float and re-install skimmer assembly back into the skimmer housing.

Bottom of Float

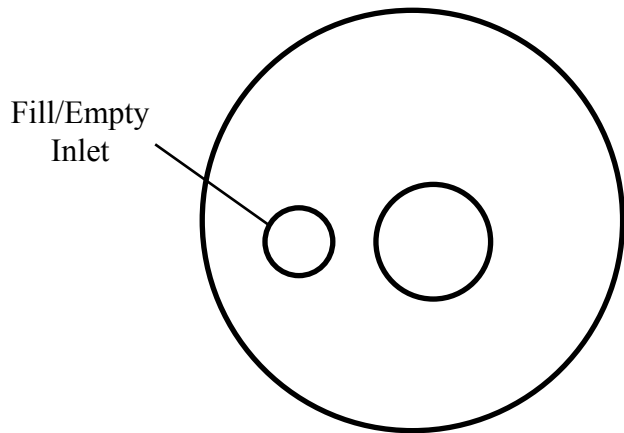

Removing The Skimmer Assembly From The Pump

1. Remove the two bolts that secure the skimming housing to the pump. Remove the lower tubing strap at the bottom of the skimmer.
2. Separate the skimming housing from the pump by feeding the black product tubing that runs along the outside of the well screen up into the well screen.
3. Loosen the tubing fitting to free the product tubing from the fitting.

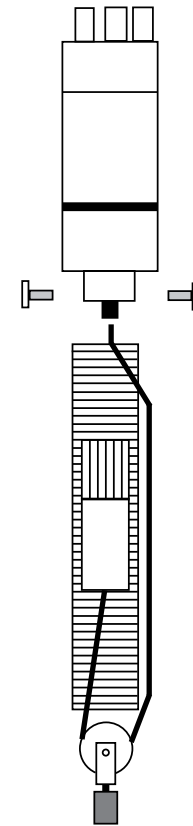

Replacing The Skimmer Filter

1. Remove the stop bolt at the bottom of the well screen housing.
2. Remove the skimming assembly from the well screen housing.
3. Remove the skimming filter from the float assembly. No tools required.
4. Push on a new skimming filter onto the float assembly and return skimming assembly to the well screen housing.
5. Secure the stop bolt to the well screen housing.

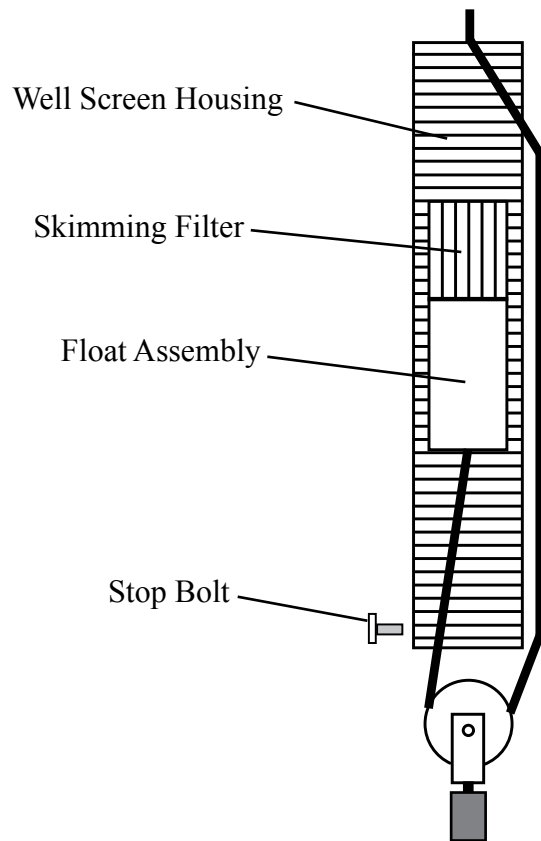

Replacing The Skimmer Diaphragm

1. Loosen all bolts until bottom can be detached. Do not separate pump head, valve housing or diaphragm from the six bolts at this time.
2. Lay pump on its side on the table and remove the diaphragm from all six bolts.
3. Place new diaphragm onto the six bolts and reattach upper pump parts with the pump bottom.

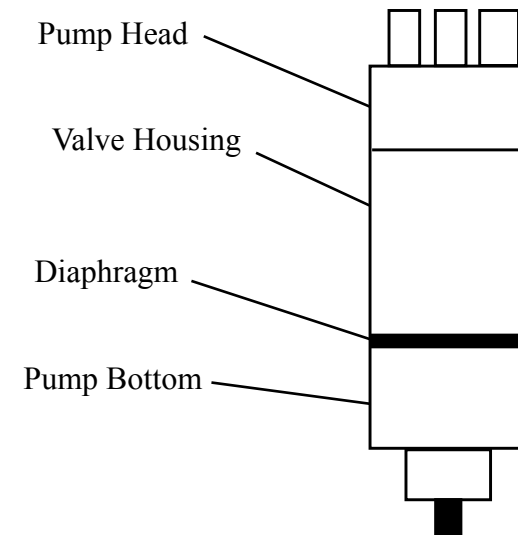

XITECH MODEL 5500ES CONTROLLER

MOUNTING

